



**Coastal**  
an Oldcastle® company

**LEGEND**

SP1S	=	SPLIT-FACE ON ONE SIDE
SPC	=	SPLIT-FACE ONE SIDE AND ONE END
SP2S	=	SPLIT-FACE TWO SIDES
SP2SC	=	SPLIT-FACE TWO SIDES AND ONE END
1S1F	=	SINGLE SCORE ON ONE SIDE
G1S	=	GROUND-FACE ON ONE SIDE
G1S1E	=	GROUND-FACE ONE SIDE AND ONE END
G2S	=	GROUND-FACE TWO SIDES
G2S1E	=	GROUND-FACE TWO SIDES AND ONE END
SMO	=	SMOOTH-FACE
L-CORNER	=	4" VENEER SPLIT ONE SIDE AND ONE END (8" RETURN)

\*\*ALL CMU ARE ASSUMED TO BE HOLLOW UNLESS OTHERWISE STATED

**4 inch**

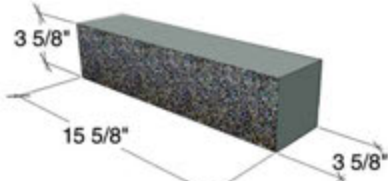

**4x4x16 SOLID - SP1S, G1S, SMO**

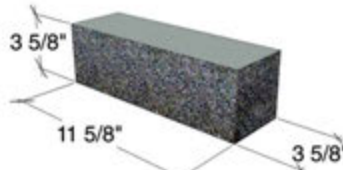

**4x4x12 SOLID CORNER - SPC, G1S1E, SMO**

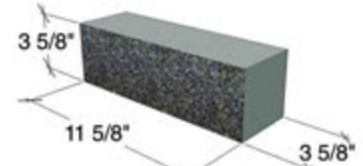

**4x4x12 SOLID - SP1S, G1S, SMO**

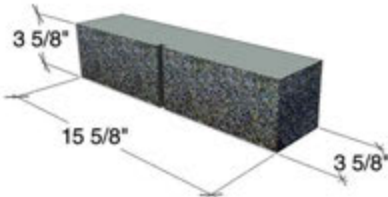

**4x4x16 SOLID CORNER 1S1F - SPC, G1S1E, SMO**

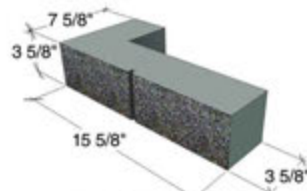

**4x4x16 1S1F L-CORNER - SPC, G1S1E, OR SMO (ALSO AVAIL. W/O 1S1F)**

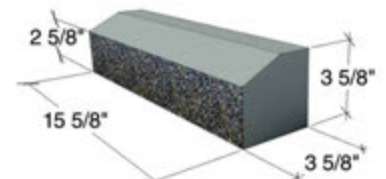

**4x4x16 SOLID SLOPED SILL - SP1S, G1S OR SMO (SLOPED FACE G OR SMO)**

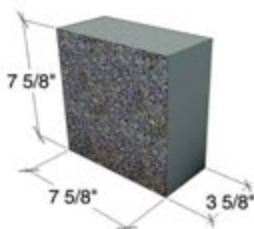

**4x8x8 SOLID - SP1S, G1S, SMO**

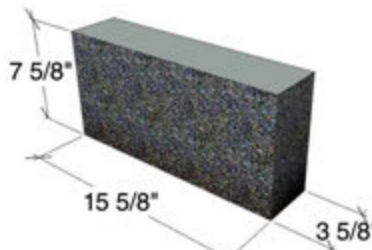

**4x8x16 SOLID - SP1S, G1S, SMO**



**4x8x16 1S1F - SP1S, G1S, SMO**

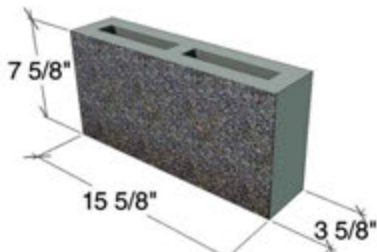

**4x8x16 - SP1S, G1S, SMO**

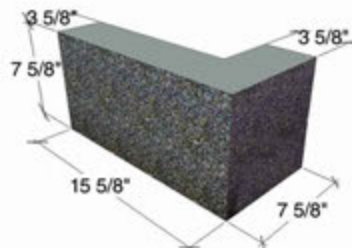

**4x8x16 SOLID L-CORNER - SPC, G1S1E OR SMO**

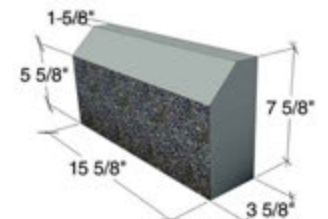

**4x8x16 SOLID SLOPED SILL - SP1S, G1S OR SMO (SLOPED FACE G OR SMO)**

## 6 inch

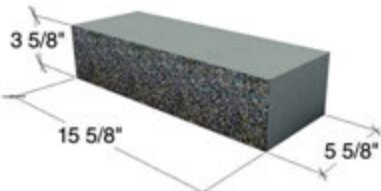

**6x4x16 SOLID -  
SPC, G1S1E, SMO**

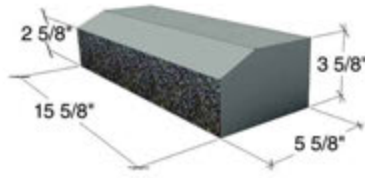

**6x4x16 SOLID SLOPED SILL -  
SP1S, G1S OR SMO  
(SLOPED FACE G OR SMO)**

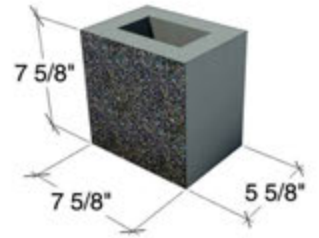

**6x8x8 HALF -  
SP1S, G1S, SMO**

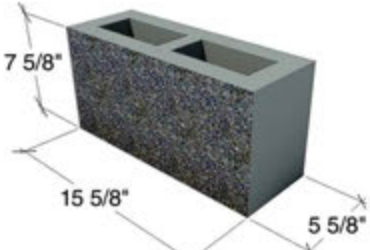

**6x8x16 1S1F -  
SP1S, G1S, SMO**

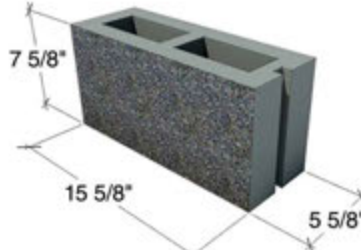

**6x8x16 SASH 1S1F -  
SP1S, G1S, SMO**

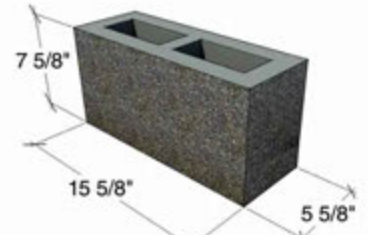

**6x8x16 CORNER -  
SPC, G1S1E, SMO**

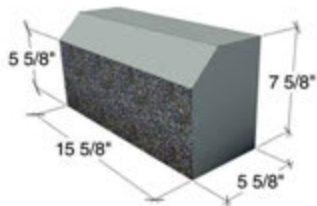

**6x8x16 SOLID SLOPED SILL -  
SP1S, G1S OR SMO  
(SLOPED FACE G OR SMO)**

## 8 inch

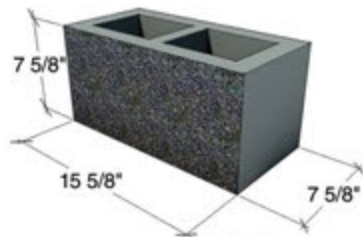

**8x8x16 HOLLOW -  
SP1S, G1S, SMO**

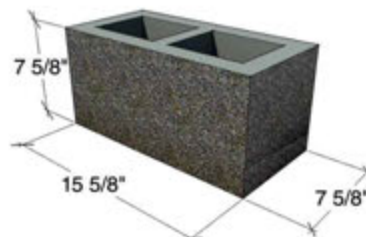

**8x8x16 CORNER -  
SPC, G1S1E, SMO**

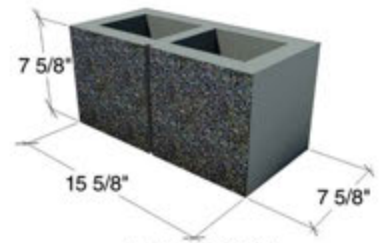

**8x8x16 1S1F -  
SP1S, G1S, SMO**



**8x8x16 KNOCKOUT BB -  
SP1S, G1S, SMO**

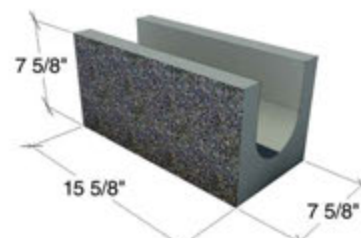

**8x8x16 SOLID BOTTOM BB -  
SP1S, G1S, SMO**

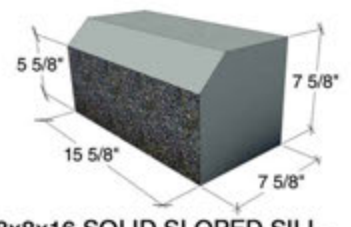

**8x8x16 SOLID SLOPED SILL -  
SP1S, G1S OR SMO  
(SLOPED FACE G OR SMO)**

# 8 inch

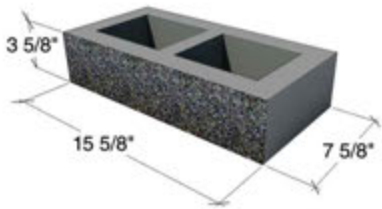

**8x4x16 HALF HIGH -  
SP1S, G1S, SMO**

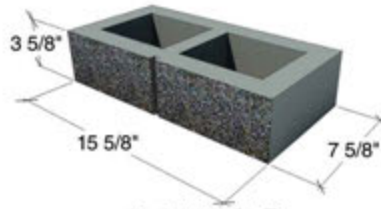

**8x4x16 1S1F -  
SP1S, G1S, SMO**

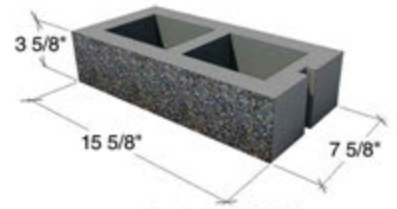

**8x4x16 SASH -  
SP1S, G1S, SMO**

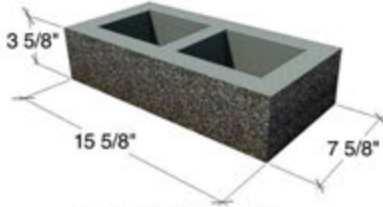

**8x4x16 CORNER -  
SPC, G1S1E, SMO**

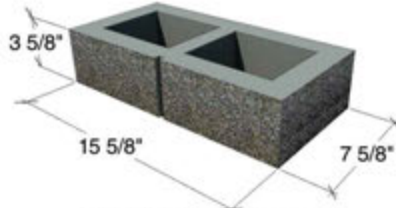

**8x4x16 1S1F CORNER -  
SP1S, G1S, SMO**

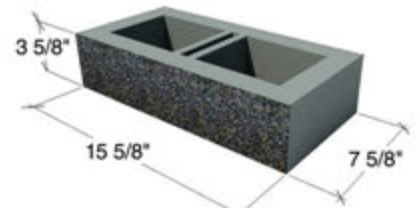

**8x4x16 SPITTABLE -  
SPC, G1S1E, SMO**

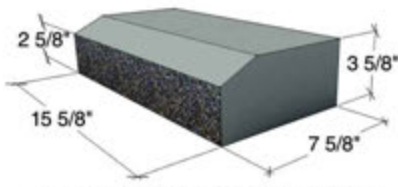

**8x4x16 SOLID SLOPED SILL -  
SP1S, G1S OR SMO  
(SLOPED FACE G OR SMO)**

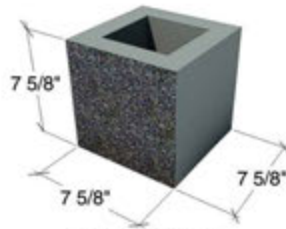

**8x8x8 HALF -  
SP1S, G1S, SMO**

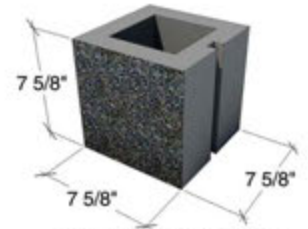

**8x8x8 HALF SASH -  
SP1S, G1S, SMO**

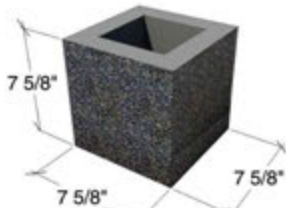

**8x8x8 CORNER -  
SPC, G1S1E, SMO**

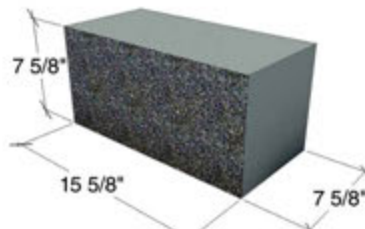

**8x8x16 SOLID -  
SP1S, G1S, SMO**

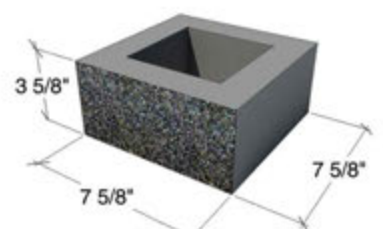

**8x4x8 HALF -  
SP1S, G1S, SMO**

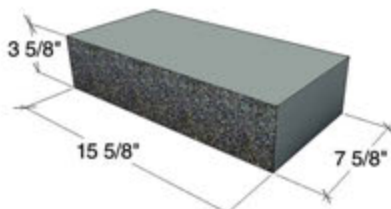

**8x4x16 SOLID -  
SP1S, G1S, SMO**

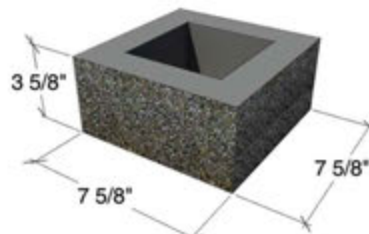

**8x4x8 CORNER -  
SPC, G1S1E, SMO**



**8x8x16 1S1F CORNER -  
SPC, SP1S, G1S, SMO**

# 10 inch

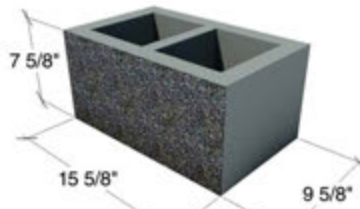

**10x8x16 HOLLOW -  
SP1S, G1S, SMO**

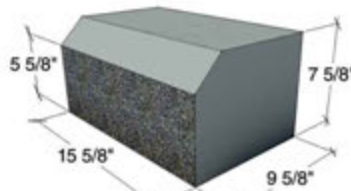

**10x8x16 SOLID SLOPED SILL -  
SP1S, G1S OR SMO  
(SLOPED FACE G OR SMO)**

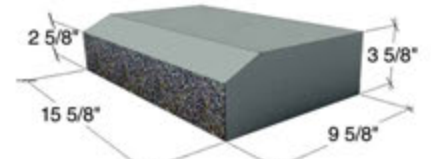

**10x4x16 SOLID SLOPED SILL -  
SP1S, G1S OR SMO  
(SLOPED FACE G OR SMO)**

# 12 inch

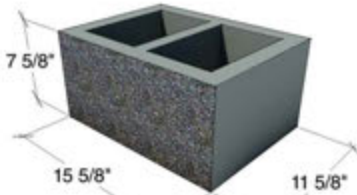

**12x8x16 HOLLOW -  
SP1S, G1S, SMO**



**12x8x16 KNOCKOUT BB-  
SP1S, G1S, SMO**

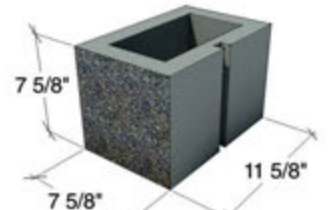

**12x8x8 SASH -  
SP1S, G1S, SMO**

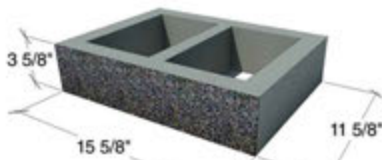

**12x4x16 HALF HIGH -  
SP1S, G1S, SMO**

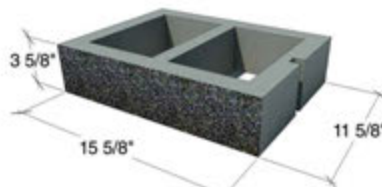

**12x4x16 SASH -  
SP1S, G1S, SMO**

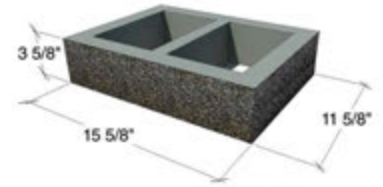

**12x4x16 CORNER -  
SPC, G1S1E, SMO**



**12x8x16 1S1F -  
SP1S, G1S, SMO**

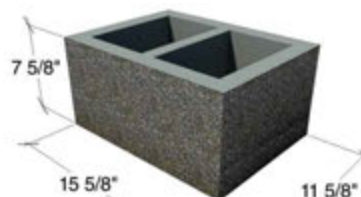

**12x8x16 CORNER -  
SPC, G1S1E, SMO**



**12x8x16 KNOCKOUT 1S1F -  
SP1S, G1S, SMO**

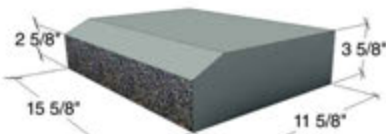

**12x4x16 SOLID SLOPED SILL -  
SP1S, G1S OR SMO  
(SLOPED FACE G OR SMO)**

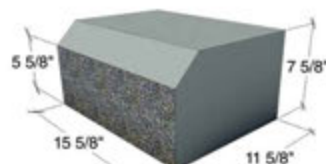

**12x8x16 SOLID SLOPED SILL -  
SP1S, G1S OR SMO  
(SLOPED FACE G OR SMO)**

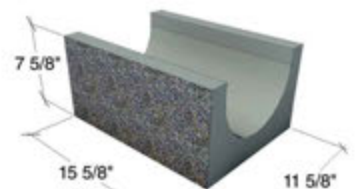

**12x8x16 SOLID BOTTOM BB -  
SP1S, G1S, SMO**

# 4 inch

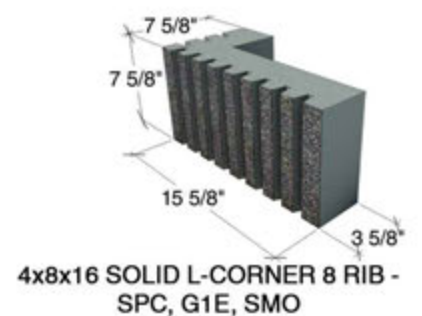
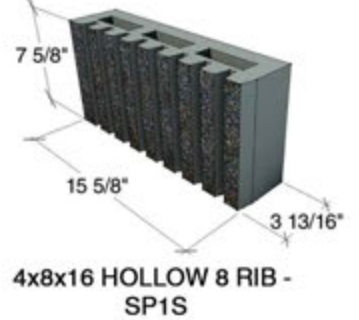
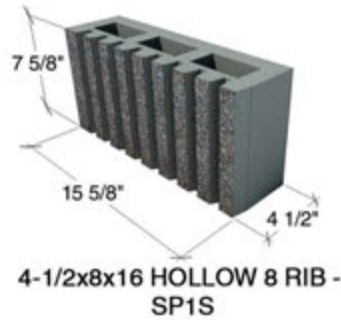
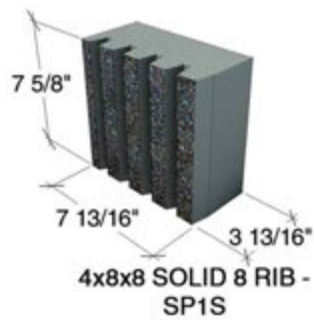
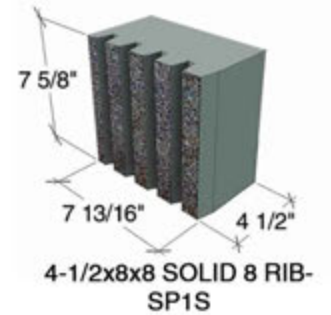
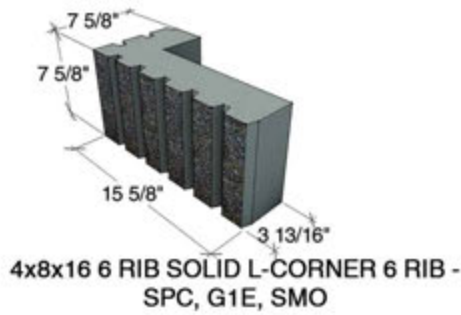
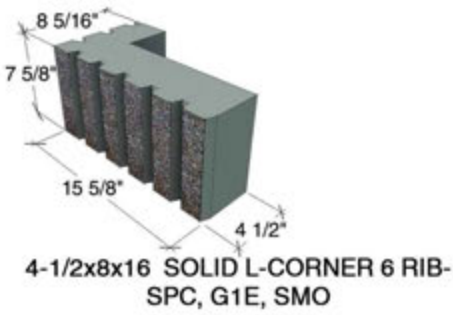
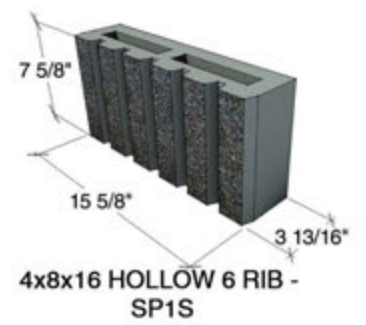
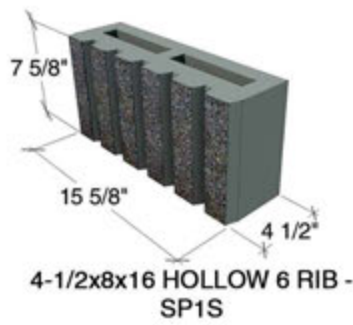
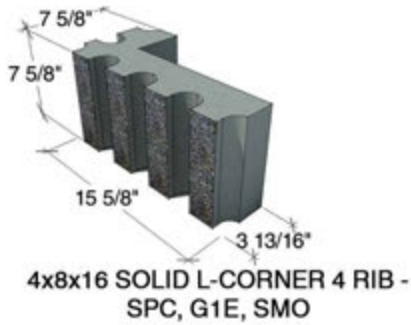
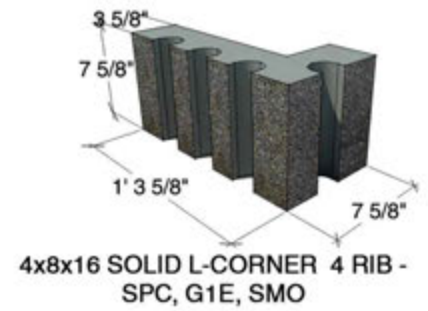
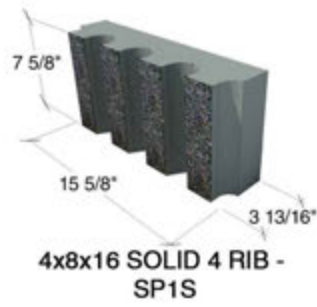

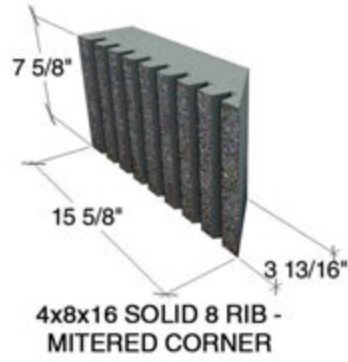
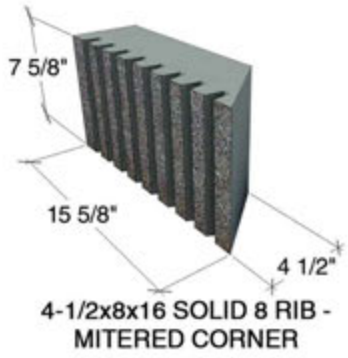

## 8 inch

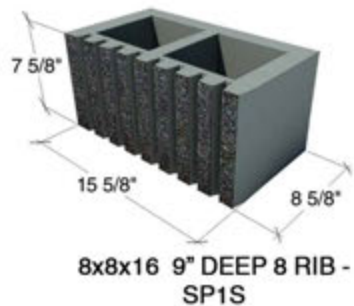
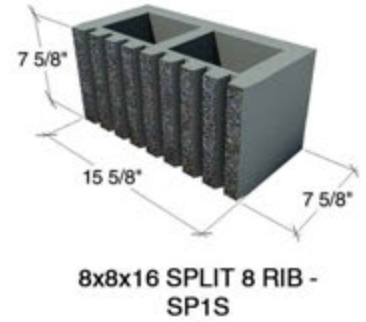
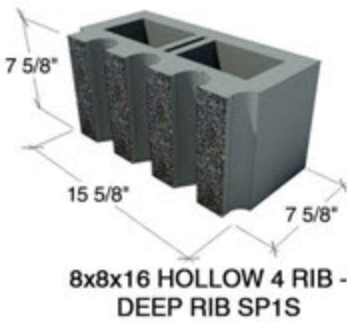
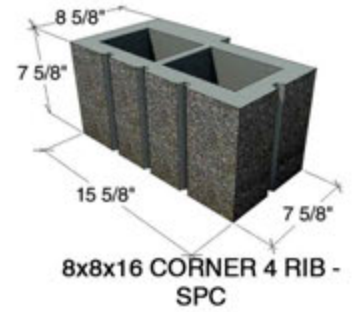
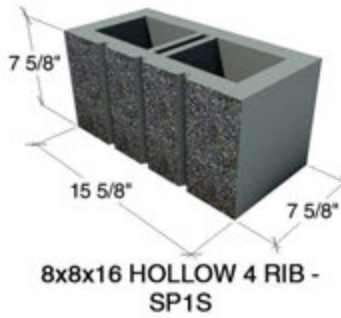
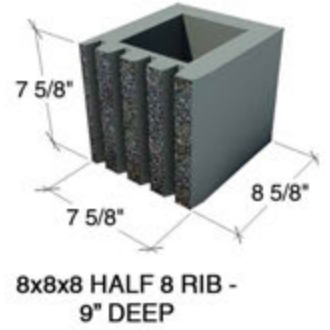
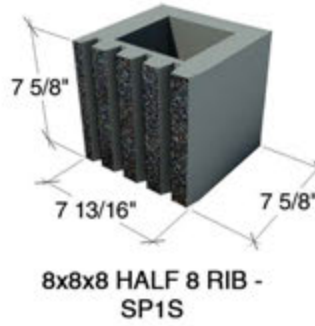
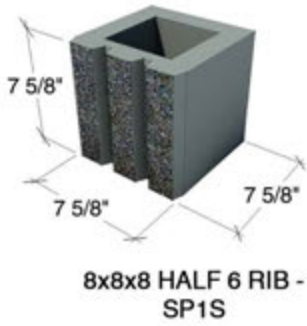

# 12 inch

